

newline

## Collaboration Touch Screen



## **HO Series**

Quick Start Guide

V1.0

**Thank you for choosing Newline collaboration touch screen.**



The symbol of the crossed out wheeled bin indicates this product should not be placed in municipal waste. Instead, dispose of waste equipment by handing it over to a designated collection point for the recycling of electrical and electronic equipment.



# Symbol Convention





---





Symbols are used in this document to indicate operations that require special attention. The symbols are defined as follows:



 <b>WARNING</b>	Indicates a hazard with risk that, if not avoided, could result in death or injury.
 <b>CAUTION</b>	Indicates a potentially hazardous situation that, if not avoided, could result in equipment damage, data loss, performance deterioration, or unanticipated results.
 <b>NOTE</b>	Provides additional information to supplement operation in the main text.



# Safety Instructions

For your safety, please read the following instructions before you use the product. Improper operations may cause severe injury or property damage. Please refrain from repairing the product on your own.

 <b>WARNING</b>	
	<p><b>If major failures occur, disconnect the product from power source immediately.</b></p> <p>Major failures include the following:</p> <ul style="list-style-type: none"> <li>• Smoke, peculiar smell or abnormal sound discharged from the product.</li> <li>• No image or sound is displayed, or if image error occurs.</li> </ul> <p>If the above scenarios occur, do not continue using the product. Disconnect power supply immediately and contact professional staff.</p>
	<p><b>Do not drop liquid, metal or anything combustible into the product.</b></p> <ul style="list-style-type: none"> <li>• If liquid or pieces of metal get into the product, turn off the power and disconnect the power source, then contact professional staff.</li> <li>• Supervise children when they are close to the product.</li> </ul>
	<p><b>Place the product on a stable surface.</b></p> <p>An unstable surface includes but is not limited to an inclined surface, a shaky stand, desk or platform, which might cause turnover and damage.</p>
	<p><b>Do not open the cover or modify the product on your own.</b></p> <p>High voltage components are installed in the product. When you open the cover, high voltage, electric shock, or other dangerous situations may occur.</p> <p>If inspection, adjustment, or maintenance is required, contact the local distributor for help.</p>
	<p><b>Use the specified power supply voltage.</b></p> <ul style="list-style-type: none"> <li>• To prevent the product from being damaged, do not use cables other than the one provided with the product.</li> <li>• Use a three-wire socket and ensure that it is properly grounded.</li> <li>• Pull out the power plug from the socket if the product is not to be used for a long period.</li> </ul>
	<p><b>Regularly clean the dust and metal around the power plug.</b></p> <ul style="list-style-type: none"> <li>• Fire or electric shock may be caused if the product is powered on, when you are cleaning.</li> <li>• Pull out the power plug before cleaning it with a dried cloth.</li> </ul>

 <b>WARNING</b>	
	<p><b>Do not place items on top of the product.</b></p> <ul style="list-style-type: none"> <li>Do not put items, such as a liquid container (a vase, flowerpot, cosmetics or liquid medicine) on the top of the product.</li> <li>If any water or liquid is spilled on the product, a short circuit may occur and cause fire or electric shock.</li> <li>Do not walk on or hang any items on the product.</li> </ul>
	<p><b>Do not install the product in an improper place.</b></p> <ul style="list-style-type: none"> <li>Do not install the product in humid places, such as the bathroom, the shower room, near windows, or outdoor environments that experience rain, snow or other harsh weather. Avoid installation near hot spring vapor. The preceding environments may cause faults in the product or electric shock under extreme conditions.</li> <li>Do not put expose the product to a fire source, such as an ignited candle.</li> </ul>
	<p><b>Pull out the power plug during thunderstorms.</b></p> <ul style="list-style-type: none"> <li>Do not touch the product during a lighting storm to avoid electric shocks.</li> <li>Install or place components that supply high enough voltage out of the reach of children.</li> </ul>
	<p><b>Do not touch the power cable with wet hands.</b></p>

 <b>CAUTION</b>	
	<p><b>Do not install the product in high temperature environments.</b></p> <ul style="list-style-type: none"> <li>Do not install the product near a heat source, such as a radiator, a heat reservoir, a stove or other heating products.</li> <li>Do not expose the product to direct sunlight, which may cause high temperatures and subsequent faults in the product.</li> </ul>
	<p><b>Transport of the product.</b></p> <ul style="list-style-type: none"> <li>Pack the product for transport or maintenance by using the cartons and cushioning material provided with the product.</li> <li>Keep the product vertical during transport. The screen or other components are easily broken if the product is moved inappropriately.</li> <li>Before you move the product, disconnect all external connections and separate all toppling preventing products. Move the product carefully to prevent it from being hit or squeezed, especially the screen, which may cause injury if broken.</li> </ul>

	<p><b>Do not cover or block up any vents on the product. Any overheated components may cause fire, damage the product, and shorten the product's service life.</b></p> <ul style="list-style-type: none"> <li>• Do not lay the product down where the venting surface will be covered.</li> <li>• Do not install the product on a carpet or cloth.</li> <li>• Do not use a cloth such as table cloth to cover the product.</li> </ul>
	<p><b>Keep away from the product when using a radio.</b></p> <p>The product complies with the international EMI standard regarding prevention of radio interference. However, interference may still exist and cause noises to the radio. If noise occurs in the radio, try the following solutions.</p> <ul style="list-style-type: none"> <li>• Adjust the direction of the radio antenna to avoid the interference from the product.</li> <li>• Keep the radio away from the product.</li> </ul> <p><b>If the screen glass is broken or falls off.</b></p> <ul style="list-style-type: none"> <li>• Keep all personnel 10 feet away from the screen to ensure safety.</li> <li>• Do not perform any installation or disassembly while the screen glass is broken or has fallen off.</li> </ul> <p><b>Do not damage the power cable.</b></p> <ul style="list-style-type: none"> <li>• Do not damage, change, twist, bend, or forcibly drag the power cable.</li> <li>• Do not put weights (such as the product itself) on top of the power cable.</li> <li>• Do not forcibly drag the cable when you pull out the power plug. If the power cable is damaged, please contact the local distributor to repair or replace it.</li> <li>• The power cable in the accessory box is for this product only. Do not use it on other products.</li> </ul> <p><b>Correct battery usage.</b></p> <ul style="list-style-type: none"> <li>• Galvanic corrosion, electric leakage, and even fire may be caused by improper battery usage.</li> <li>• It is recommended to use the designated type of battery and install the battery by correct electrodes (positive and negative).</li> <li>• Do not use a new battery alongside a used one.</li> <li>• Take out the batteries if the remote control is not to be used for a long period.</li> <li>• Do not expose the batteries to overheated environments such as sunlight and firing.</li> <li>• Dispose of used batteries based on your local regulations.</li> </ul> <p><b>Suggestions for usage:</b></p> <ul style="list-style-type: none"> <li>• Use the product in an environment with comfortable lighting. It is harmful to your eyes to watch in a too bright or too dark environment.</li> <li>• Rest your eyes after an extended period of usage.</li> <li>• Keep sufficient distance from the product to protect your eyes and prevent eyestrain.</li> <li>• Adjust the volume to an appropriate level, especially at night.</li> <li>• Use amplifier equipment as the audio input source with caution. If you must use amplifier equipment, the input power should not exceed the maximum of speaker power. Otherwise, the speaker can become overpowered and damaged.</li> </ul>

	<p><b>About USB port.</b></p> <p>Front USB ports and rear USB 3.0/USB 2.0 ports switch connections based on signal sources. If the current signal source is reading the data from an external product connecting to the port, please switch the signal source after the data reading is complete. Otherwise, the data or product may be damaged.</p>
	<p><b>Special note:</b></p> <ul style="list-style-type: none"><li>• Under the premise of ensuring the display quality, the energy consumption can be reduced by reducing the brightness of the display.</li><li>• This product can be paired with various OPS Computers, which can be upgraded or replaced according to your needs.</li></ul>

# 1 Overview

---

## 1.1 Parts

---



### CAUTION

There are electronic components in the plastic parts at the bottom of the product. If the plastic parts are damaged, the camera or the product may malfunction. To avoid damage to the plastic parts, please pay attention to the following:

- Do not squeeze, knock at or disassemble the plastic parts.
  - Do not place heavy objects on plastic parts.
  - When transporting the product, do not impact the plastic parts at the bottom.
  - When transporting the product, do not place the plastic parts on the ground.
-



Front view

65/75/86 inch:

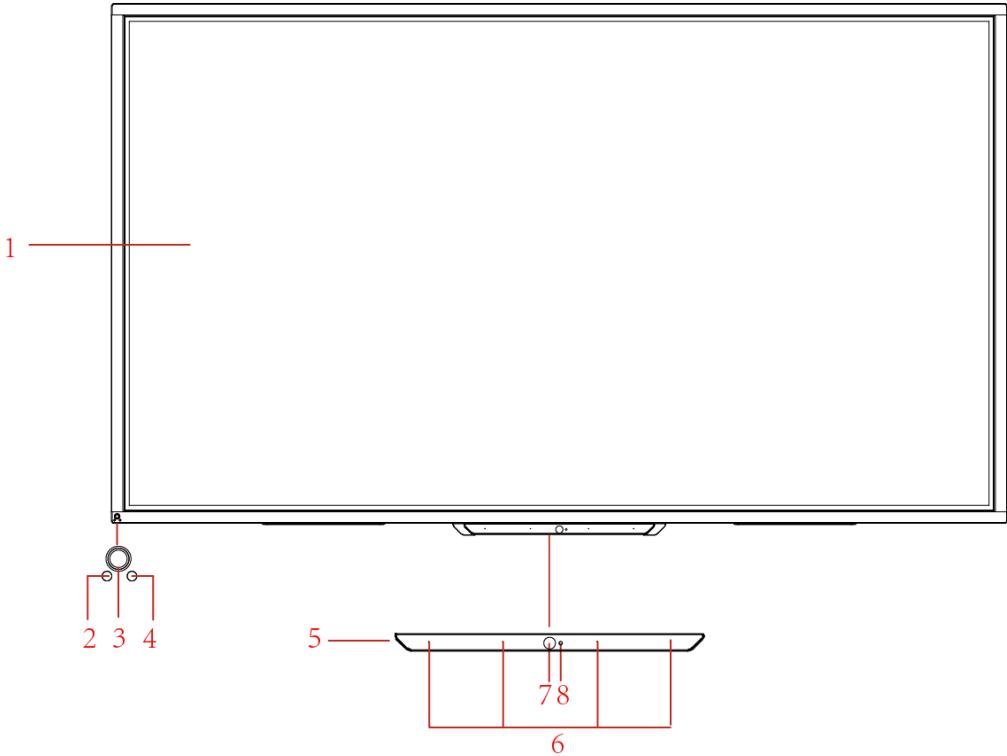

Rear view

65/75/86 inch:

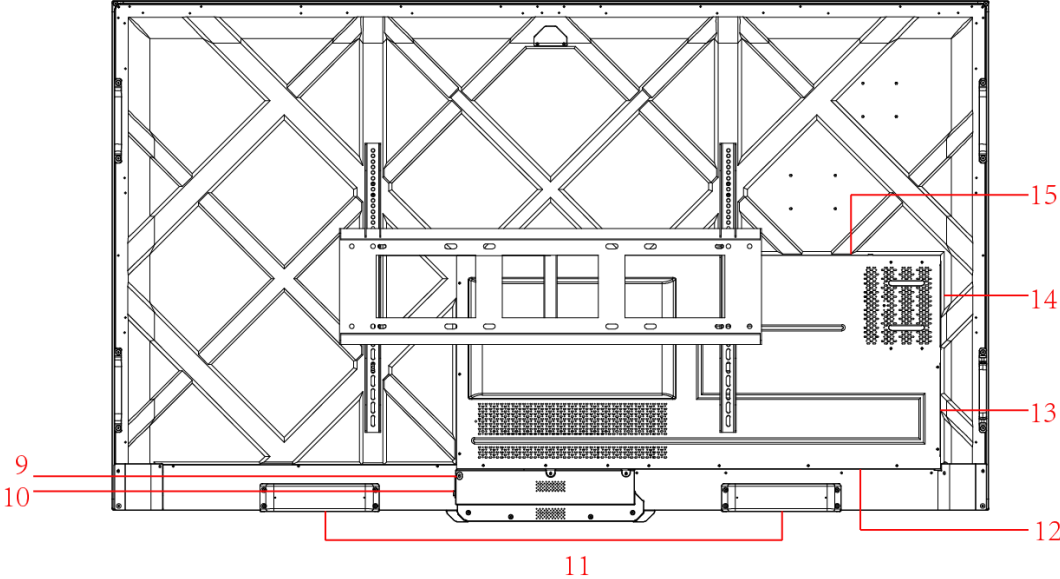

1	Touch screen	9	Power socket
2	Light sensor	10	Power switch
3	Power button	11	Speaker
4	IR receiver	12	Rear port 1
5	Bottom plastic part	13	Rear port 2
6	Microphone	14	OPS Computer slot
7	Camera	15	SoundBar port
8	Camera indicator		

## 1.2 Front Buttons

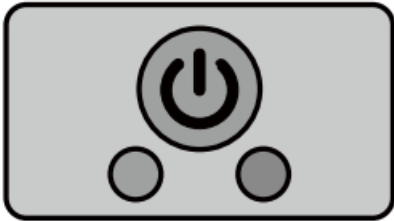

Name	Function description
	<p>Power on/off.</p> <ul style="list-style-type: none"><li>• Turn on: press it to turn on the display, the power indicator will turn to green.</li><li>• Turn off: press it to shut down. The power indicator will turn to red.</li></ul>

**Note:**

Press the power button in the power-on state, the product enter shut down mode by default. Users can enter “settings > power >power option” to set the system to enter power off or sleep mode.

## 1.3 Rear Ports

---

### **WARNING**

- USB 3.0/USB 2.0 ports switch connections based on signal sources. If the current signal source is reading the data from an external storage connecting to the port, please switch the signal source after the data reading is complete. Otherwise, the data or product may be damaged.
  - USB2.0/USB3.0 ports output: 5V/500mA (Max.), Type C port output: 5V/3A. For qualified device use only otherwise may cause electrical shock or fire.
  - Soundbar Connecting port output: 18V/3A. Soundbar connecting port may only use for TS-series Soundbar. The manufacture cannot be responsible for the possible damage caused by connecting to other devices.
-

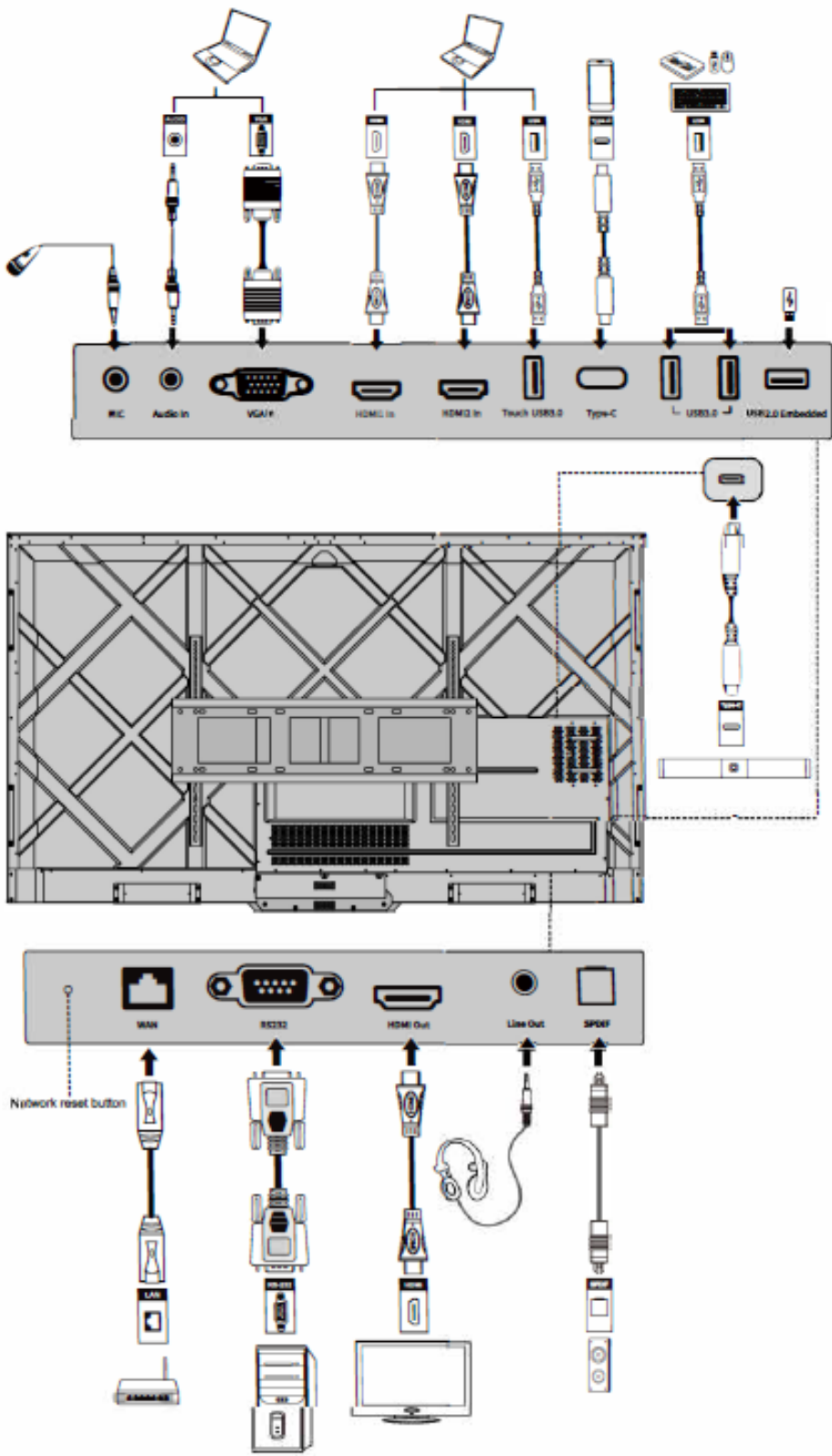

Name	Function description
MIC	Microphone input port
Audio in	Audio input port, used in combination with “ <b>VGA In</b> ”.
VGA in	VGA signal input port. Used in combination with “ <b>Touch USB 3.0</b> ” to operate the PC in touch mode.
HDMI 1 in	HDMI signal input port 1. Used in combination with “ <b>Touch USB 3.0</b> ” to operate the PC in touch mode.
HDMI 2 in	HDMI signal input port 2. Used in combination with “ <b>Touch USB 3.0</b> ” to operate the PC in touch mode.
Touch USB 3.0	Connect to the touch port of your PC.
Type C	Connect to USB flash drive, MAC, PC, or mobile phone with OTG function. Output 5V 3A power supply. Support data, audio, video, and charging. The transmission rate is 5Gbps. The maximum resolution of video transmission is 3840 x 2160@60Hz.
USB 3.0	Connect to USB devices such as mobile hard disk, USB flash drive, USB keyboard and mouse. Note: Users can enter “ <b>Setting &gt; Input and output &gt; USB connection</b> ” to choose the system (OPS or Smart system) for USB port. If users choose the public, when the interface is Smart system, the device on the USB is used by Smart system. When it switches to OPS, the USB device is connected to OPS.
USB 2.0 Embedded	For local playback and system upgrade
WAN	Network interface, connecting to RJ45 terminal
Network reset button	Press the reset button for 5 seconds with a pinhole object to reset the network settings of the product to default.
RS232	Serial port signal input interface, which allows inputting serial port settings through a specific serial port control device to achieve the purpose of controlling the product.
HDMI Out	Connect to an electronic video device with HDMI input
Line Out	Connect to audio output device such as headphone and speaker.
SPDIF	Digital audio interface, optical output interface. Connect audio equipment with fiber optic input; such as amplifiers, stereos, and speakers.



















Name	Function description
Soundbar	Connect to TS series Soundbar <b>(optional)</b> Warning: TS Series Soundbar Connector port only use for TS series Soundbar. The manufacture cannot be responsible for the possible damage caused by connecting to other devices.

# 1.4 Remote Control

## 1.4.1 Remote Control Buttons





Button	Function
	Power on/off.
	Return to home source
External device	Operate the external device(Automatic learning function)
^v<>	Up/Down/Left/Right selection button.
	Confirm button.
	Mute or unmute.
	Microphone mute or unmuted.
	Press once to return to the previous page; Press twice to exit the current program. Note: In the settings page, press once to exit.
	Take a screenshot.
	Freeze the screen. Click to pause the screen interface and the freeze icon appear on the right upper, click again or touch the screen to exit pause.
	Enter/exit Sound Only mode
	Open the task manager
	Open the signal source menu(unavailable in Smart system interface)
	Increase the brightness
	Decrease the brightness
	Decrease the volume
	Increase the volume
	Switch to the OPS Computer source.
	Enter the external signal source selection page
	Adjust the Backlight mode (ECO>Standard>Auto>Custom)
	Enter the System Settings

## 1.4.2 Remote Control Usage Instructions

### CAUTION

To avoid potential malfunctions, please read the following instructions and use the remote control appropriately.

- Do not drop or smack the remote control.
- Do not spill liquids on the remote control.
- Do not place the remote control on a wet object.
- Do not expose the remote control to direct sunlight or other heat sources.

Use the remote control within 5 meters in front of the remote-control receiver and at an approximate 30° angle from both sides.

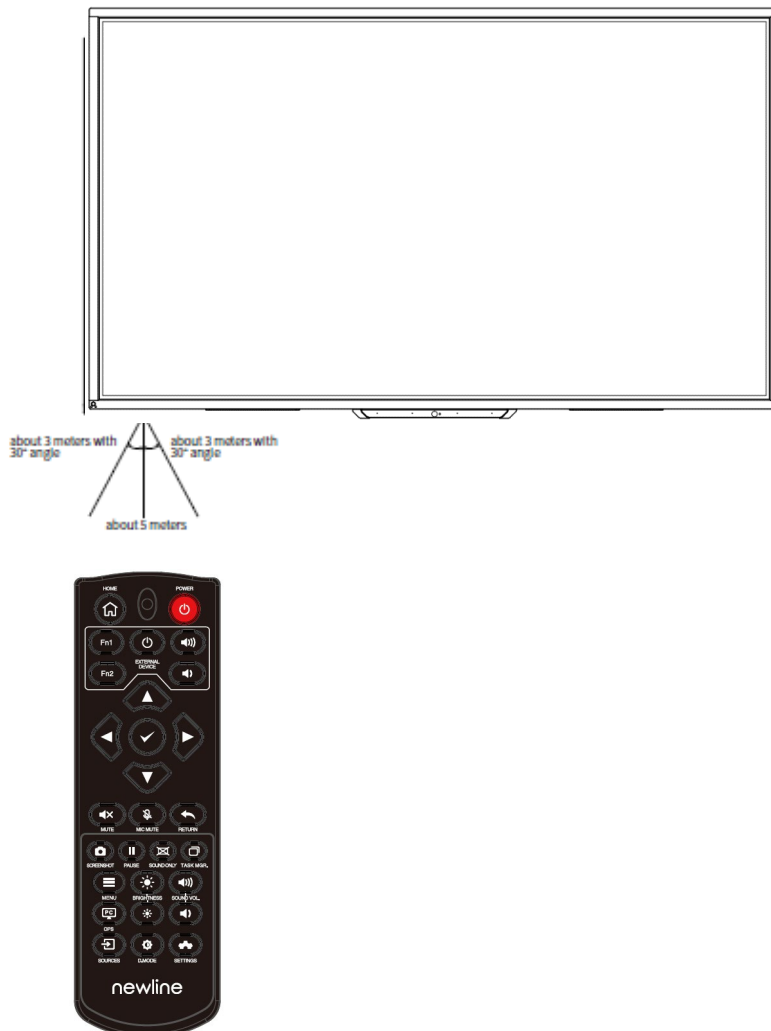

# 2 Installation Guide

## 2.1 Safety Precautions

### Environment



### Direction

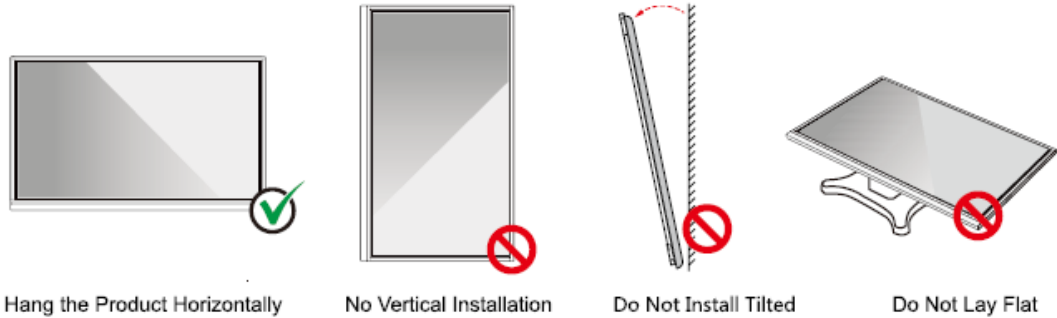

## 2.2 Installation Precautions

### Load Bearing

You can select moveable installation or wall mounting according to your own needs. Wall mounting can help users significantly reduce occupied space.

When using moveable installation, use the mobile stand specified by the manufacturer. If you use a self-made mounting bracket, its carrying capacity should be at least 4 times the actual carrying weight. The carrying capacity of the support table should be at least 4 times the actual carrying weight, and the product shall be stably mounted.

When using wall mounting, the mounting surface carrying the product should be strong enough to bear at least 4 times the actual carrying weight. When the mounting surface is the wall or roof of a building, it must be solid brick, concrete or a mounting surface of equivalent strength. If the mounting surface is loose (such as old-style brick walls, wood, solid brick walls, etc.), or a metal or non-metal structure, or if the surface decoration layer is too thick and obviously insufficient in strength, reinforcement and support measures should be implemented to prevent potential safety hazards.

### Vertical installation

When installing, try to keep the product vertical. Excessive tilt angle may cause the screen glass to fall off or the product to collapse.

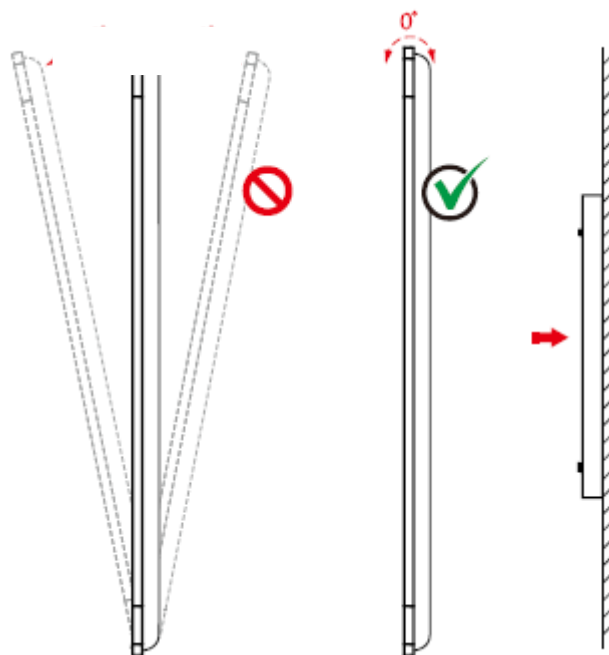

#### Note

- In case of screen glass breakage, keep all personnel 3 meters away from the screen to ensure safety.
- Do not perform any installation or disassembly when the screen glass is broken or falls off.
- For any problem, please contact our support desk. Our company is not responsible for any damage or losses incurred by users if the users fails to follow the instructions.

- *Attaching the VESA Mounting Bracket. This apparatus is intended to be supported by a GS Listed wall-mount bracket.*

Ventilation

Distance from mounting surface (mm)			
Left and right sides	Top	Bottom	Rear
100	200	200	100



- Caution**
- *In addition to the above requirements, the area of the bottom, side and top vents should not be less than 50% of the sealing area and good air circulation must be maintained when the product is embedded in the wall and a cabinet.*
  - *For wall mounting, the depth of wall bolts should be greater than 10mm.*

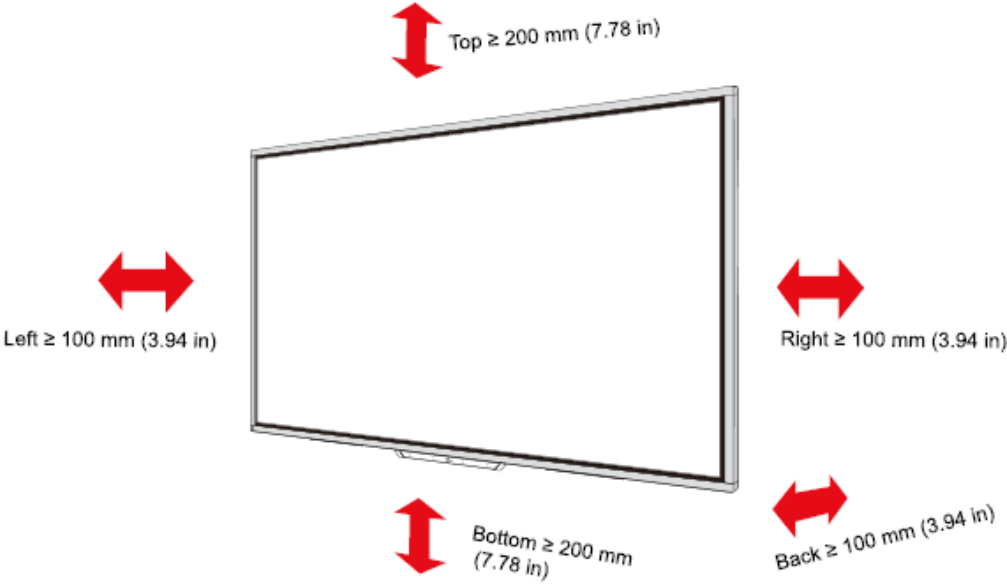

## 2.3 OPS Computer Installation

---

### **WARNING**

Do not perform the following on the OPS Computer, or the product may be damaged or end up being unusable!

- Do not plug or unplug the OPS Computer with power connected. Please make sure that the power has been turned off before plugging/unplugging.
  - Do not use the OPS Computer before the screws have been tightened or if any screws are missing.
- 

Step 1. (Optional) Unscrew the M3 screws by hand to remove the OPS Computer shielding cover.

### **Note**

This step is optional and suitable for models with the OPS Computer shielding cover.

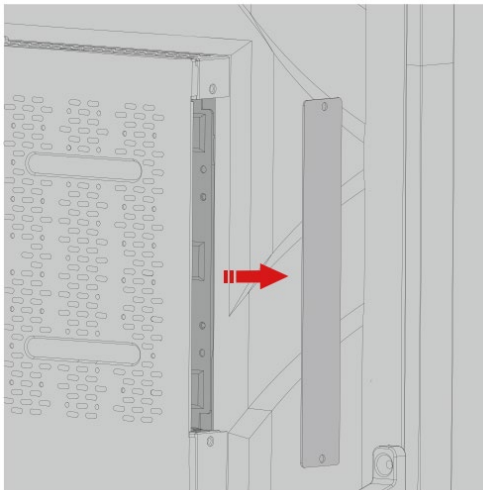

Step 2. Push the OPS Computer horizontally into the interface card slot.

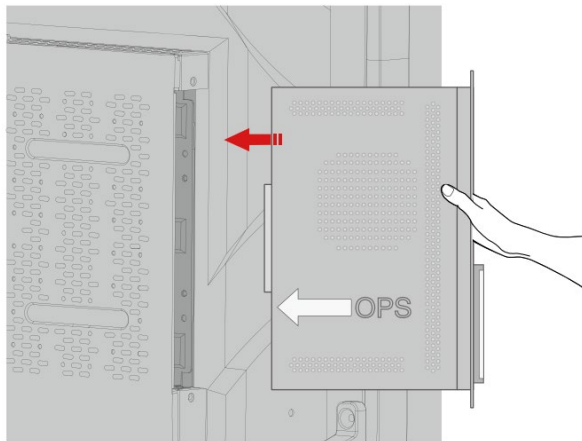

Step 3. Pass the fixing screws through the upper and lower lugs and tighten them.

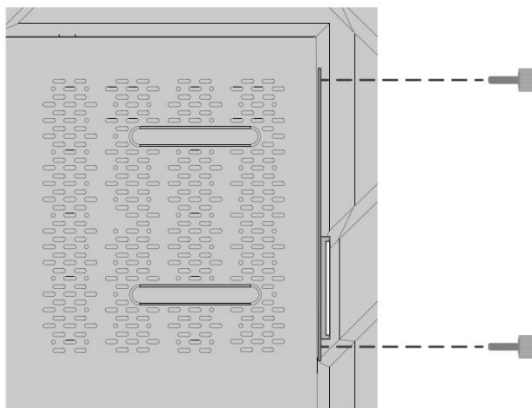

**Note**

If the screen fuzzes, flashes or if no signal is received from the OPS Computer channel after turning on the power, it means that the OPS Computer has not been properly installed. Please check it and re-install.

# 3 Power ON/OFF

## 3.1 Power on

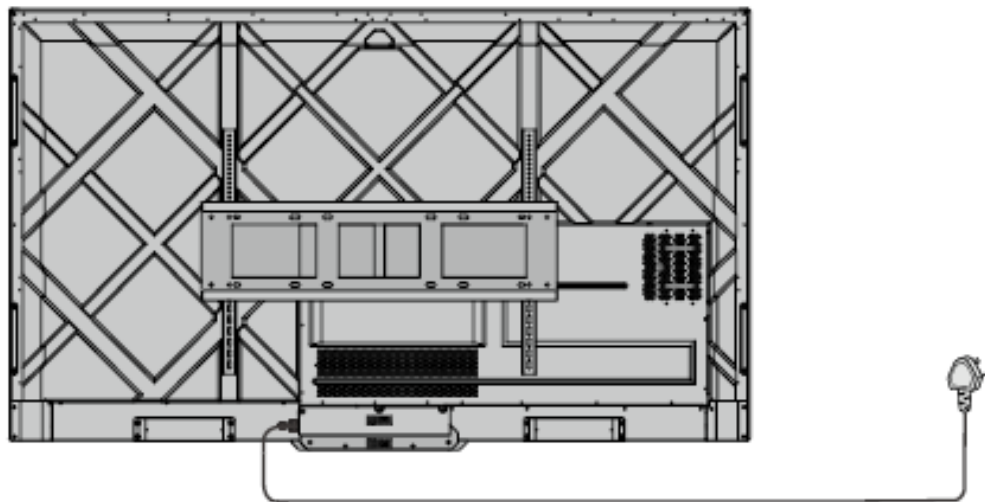

Step 1. Use AC power (100V~240V, 50Hz/60Hz) as the product power source. Make sure the power plug fully inserted and that the ground wire of the outlet is properly connected.

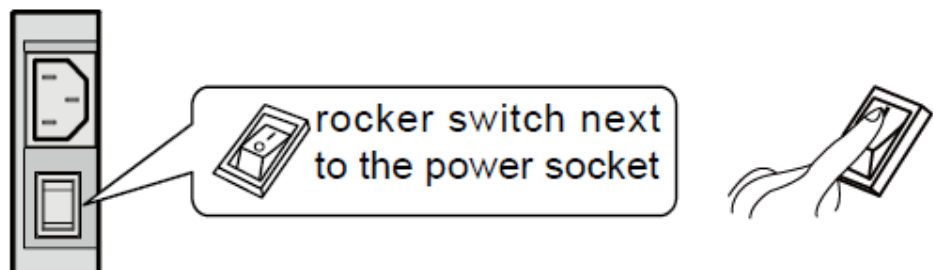

Step 2. Turn on the rocker switch (on the rear side of the screen, next to the power socket) after a power source has been connected. The power indicator should be red.







Step 3. Press the “” button on the product or the “” button on the remote control to start the product (the indicator light turns green).



## 3.2 Power off

Step 1. Power off the screen in the following situations:

- If there is no whiteboard data or screenshot(s), press the power button  on the front panel or the power button  on the remote control to power off the screen. Go to Step 4.
- If there is whiteboard data or screenshot(s), store your meeting documentations before powering off the touch screen. Otherwise, the product will delete your meeting documentations after the meeting is complete.

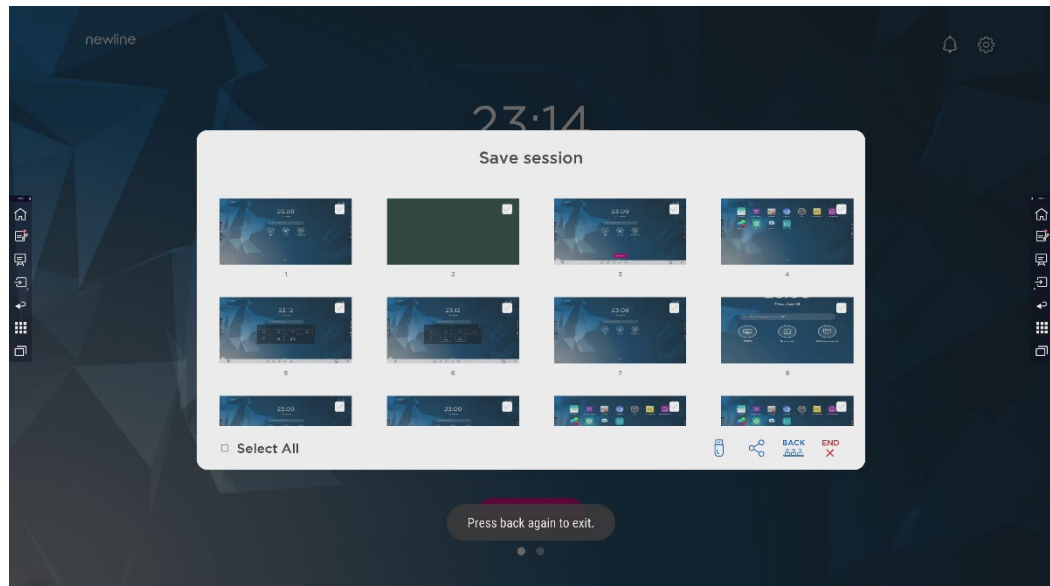
Press the power button  on the front panel or the power button  on the remote control. The **Save session** page will be displayed as shown in the following figure.



Step 2. Press the power button  on the front panel or the power button  on the remote control again. The **Warning** dialog box will be displayed as shown in the following figure.

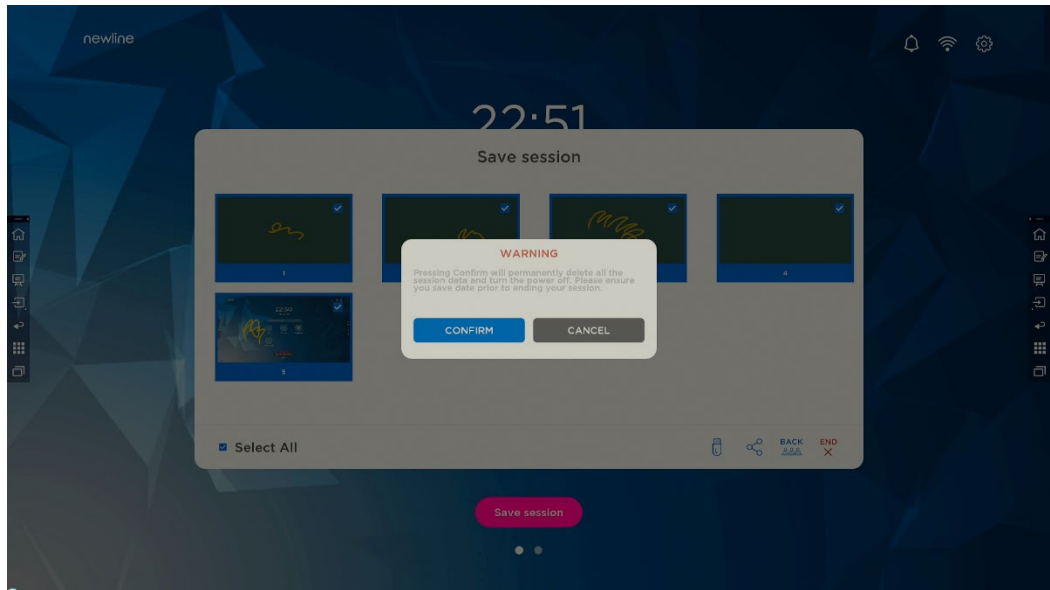

Step 3. In the **Warning** dialog box, click **Cancel**. You can save files if desired. After files are saved, return to Step 2. Click **Confirm**, and the power indicator will turn to red.

Step 4. If you want to completely turn off the product, turn off the rocker switch under the product (next to the power socket) and unplug the power cord.

## CAUTION

- When the product enters sleep mode or shutdown, the system will first detect whether the OPS Computer is turned off. If not, it first turns off the computer before it enters sleep mode or shutdown.
- Please shut down the product before disconnecting the power source or it may damage the machine. Accidental power failure may cause damage to the machine.
- Do not repeatedly turn the power on & off in a short period of time as it may cause malfunction.

Indicator	Product status
Off	Shut down or power disconnected
Red	Shutdown
Green	working state

# 4 Operating the Touch Screen

## 4.1 Home

When the product is turned on, the product will show the Home page, as shown in the following figure:

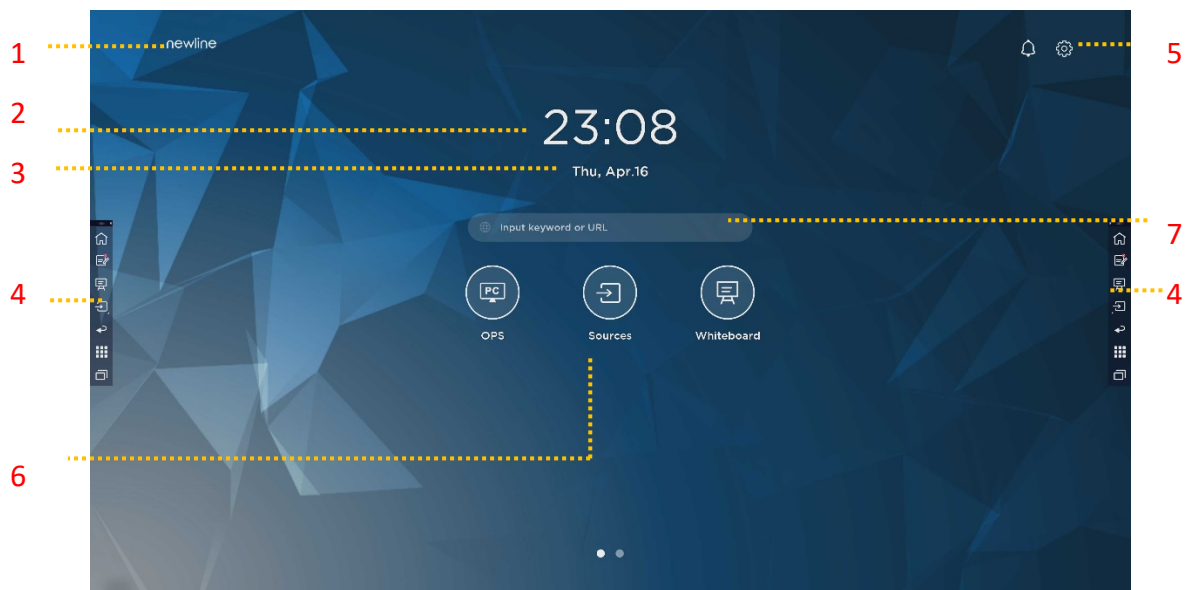









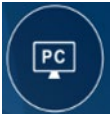

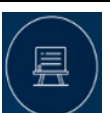
- 1: Logo (Shortcut to Settings)      2: Clock (Shortcut to Clock)  
 3: Date and Week(Shortcut to Calendar)      4: Side Toolbar      5: Status Bar and Settings  
 6: Main Icon (Dock)      7: Search Bar

Note:

On the homepage interface, swipe left to switch to the gadget interface. Users can switch the interface between the Home and Gadget by sliding left and right.

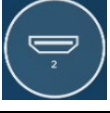
Main Icons

Icons	Functions
	Switch to the OPS Computer source.
	Click <b>Sources</b> to view the connected sources, including Built-in PC, HDMI 1, HDMI 2, VGA, Type C, Newline cast and Files.
	<b>Whiteboard</b> takes you to the whiteboard function and screen annotation functions.
	Click “ <b>Newline Cast</b> ” to enable the wireless screen sharing function.
	Switch to the VGA source
	Click <b>File viewer</b> to open the File Manager to explore internal and external files on the display.
	Click <b>Office viewer</b> to open the Office Suite application.
	Switch to the Type C source
	Switch to the HDMI 1 source
	Switch to the HDMI 2 source
	Long press the icons in the dock, you can enter the customization mode. Click <b>Add</b> to customize the icons or rename it. You can add up to 6 shortcuts to your favorite functions. (See more detail in “Add Shortcuts to Home Page”)

Note:

Users can add or remove main icons as your need (OPS, Sources, whiteboard are defaults). More details refer to 5.1 Add Shortcuts to Dock.

- **Side Toolbar**

Home, Annotation Mode, Whiteboard, Sources, Return, Gadget and Task manager icons are displayed by default in the sidebar on both sides of the screen. Users can enter “Settings”> “Toolbar” to customize the sidebar icon.

You may hide sidebar in the Settings or move it on the screen, shrink or expand by using touch gestures. You may tap the “<” to expand the sidebar. Press the Source icon to unfold level-2 icons.

Shrink

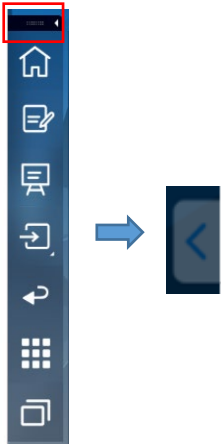

Expand

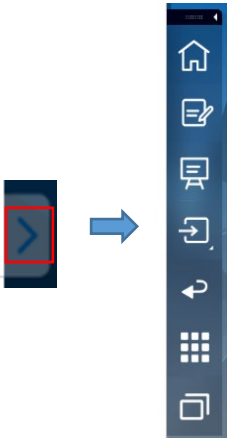

Unfold level-2 icons







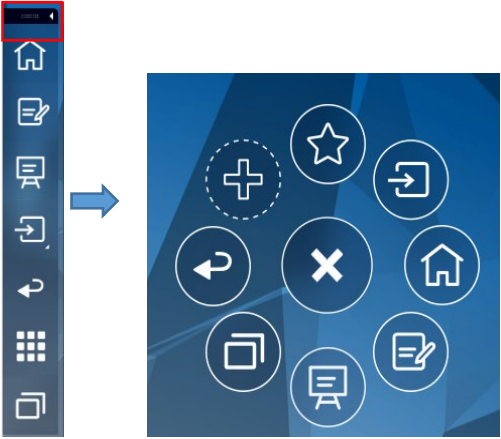

Sidebar > Floating bar

Press the black area above and pulled out, the sidebar can be transformed into a floating bar.

In the floating bar, users can add and delete icons, add custom icons, and drag the floating bar with their fingers to move around on the screen.









The functions of the sidebar are as follows:

Icon	Functions
	Go to Home page.
	Enter annotation mode, and click again to exit annotation mode and take a screenshot.
	Access whiteboard mode.
	Click to view the external signal sources, including OPS, HDMI 1, 2, VGA, Type C, Newline Cast and Files.
	Return to the previous menu/Exit an app.
	Enter the Gadgets interface. Gadget displays all pre-installed applications. Click the icon of an application to run the application.
	Manage currently running applications. Slide left/right the currently running application or click “clear all” at the upper right corner to clear all the applications.

## Status Bar and Settings

The upper right corner of the home page displays working status icons (including USB drive(s), Ethernet, and Wi-Fi), Notification and system setting shortcut.

Icon	Functions
	Click to enter the Notification page ( Show red dots when there is a notification ) .
	If USB drive is connected to the USB port, this icon will appear.
	If the product is connected to Ethernet, the icon will appear.
	If the product is connected to a wireless network, the icon will appear.
	Access the system setting page.
	The icon will appear when the product enter Freezing mode.

## 4.2 Save session

**Save session** button will appear at the bottom of the screen when there is whiteboard data, new screenshot data. Click **Save session** button or tap the power button to enter the Save session pop-up window. Users can save the session file as their needs.

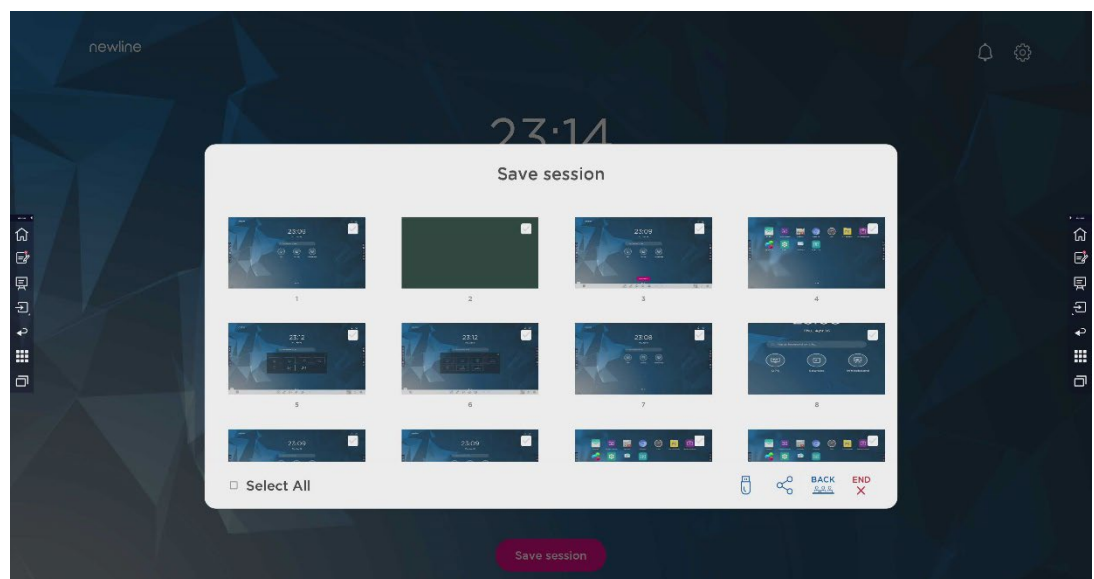

Note:

The Save session function will only save the data generated in this meeting, the previous session data will not appear.



# 5 Add Shortcut

---

## 5.1 Add Shortcuts to Dock

Step 1. Long press any one of icons in the dock bar to enter the editing state. As shown in the following figure:

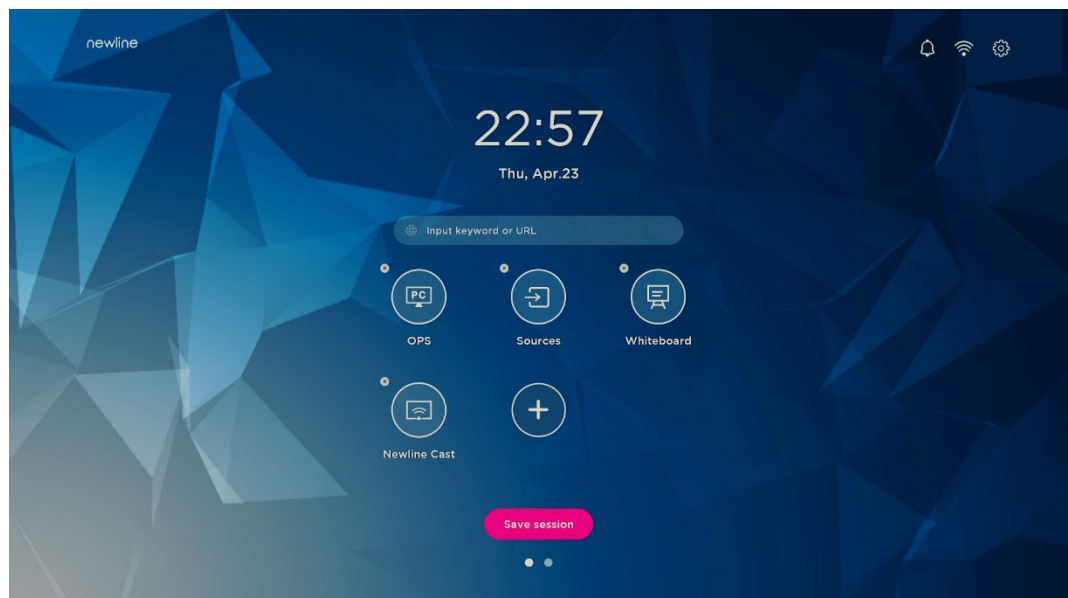

Step 2. Click the "+" icon to enter the add **Main Icon** interface, users can add up to 6 icons, as shown in the following figure:



Step 3. At the **Home** page, click the shortcut icon and you can start the program/application or change to the external signal source.

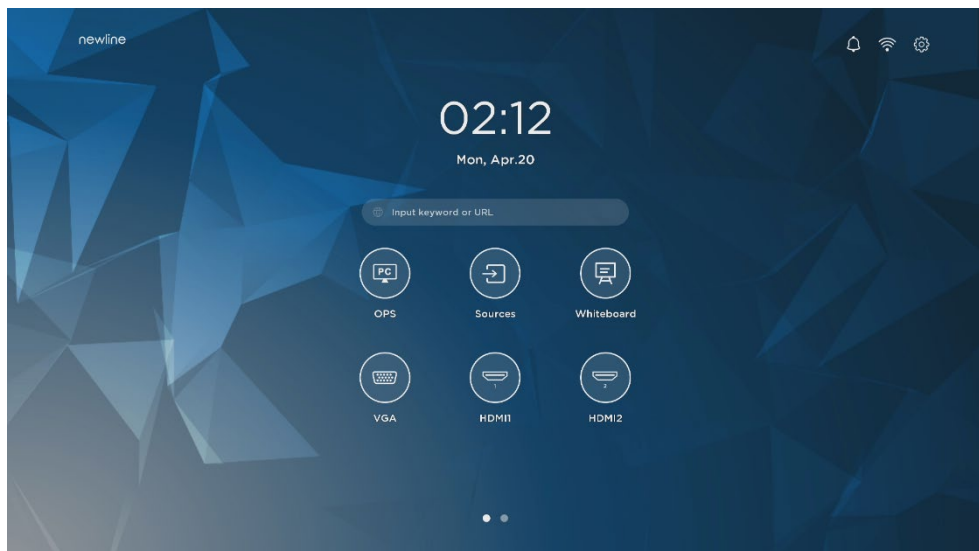

Note:

Long press the icon to enter the edit state, the + icon will not appear when the 6 main icons are all added.

## 5.2 Delete shortcuts to Dock

Long press any one of icons in the dock bar to enter the editing state. Click the × icon in the upper left corner to delete the Main Icon.

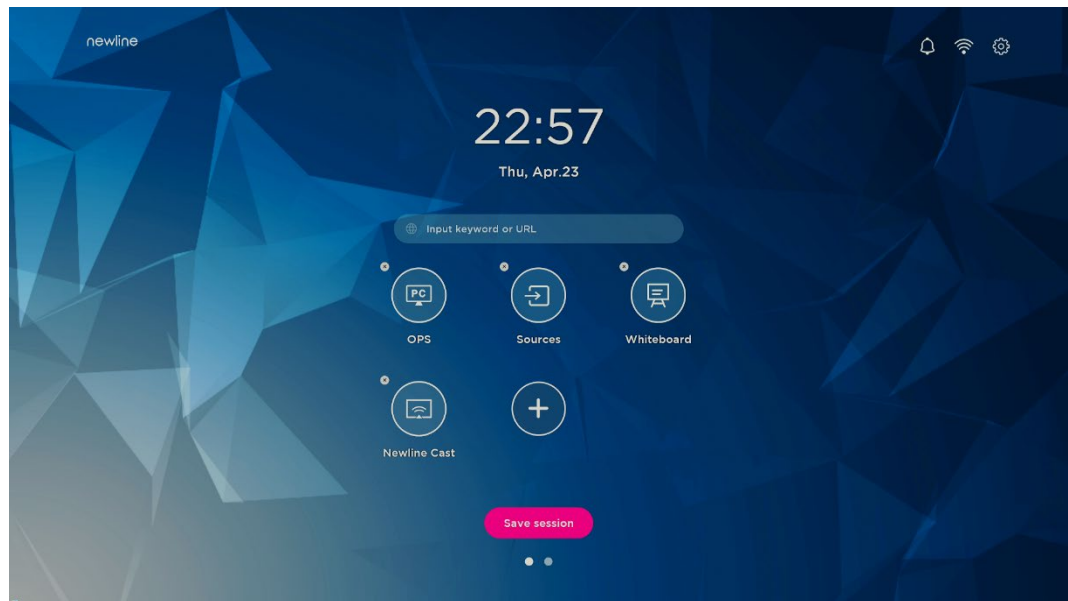

Note:

Users also can click the icon name to modify as your need.

## 5.3 Newline Assistant

### 5.3.1 Introduction

The Newline Assistant is the tool used as a bridge between the smart system and the OPS Computer (OPS). It helps add Windows software shortcut to the gadget Page, as well as to protect USB data when switching between sources.

Therefore we strongly recommend users install the Newline Assistant after installing the OPS Computer.

### 5.3.2 Installation

- Step 1. Connect OPS Computer correctly (See also "2.3 OPS Computer Installation").
- Step 2. On the **Home Page**, click **OPS**. It will switch the signal source to the Internal Windows system.
- Step 3. Visit our website at [www.newline-interactive.com](http://www.newline-interactive.com) and choose **Products > HO series > download** to download the Newline Assistant installation package.
- Step 4. Install the Newline Assistant as instructed.

### 5.3.3 Add Quick Start Windows Programs in Smart System

- Step 1. In Windows, run the **Newline Assistant** program and drag the software icons or folder shortcut icons that you want to add from the desktop or menu to the **Newline Assistant** window. The applications added or deleted through the Windows system will be automatically updated to the smart system until the upload progress reaches 100%. If there

is an application not updated, click  in the upper right corner to manually update all icons in the Newline assistant window to the smart system.

 **TIP**

Only folders and .exe file are supported.

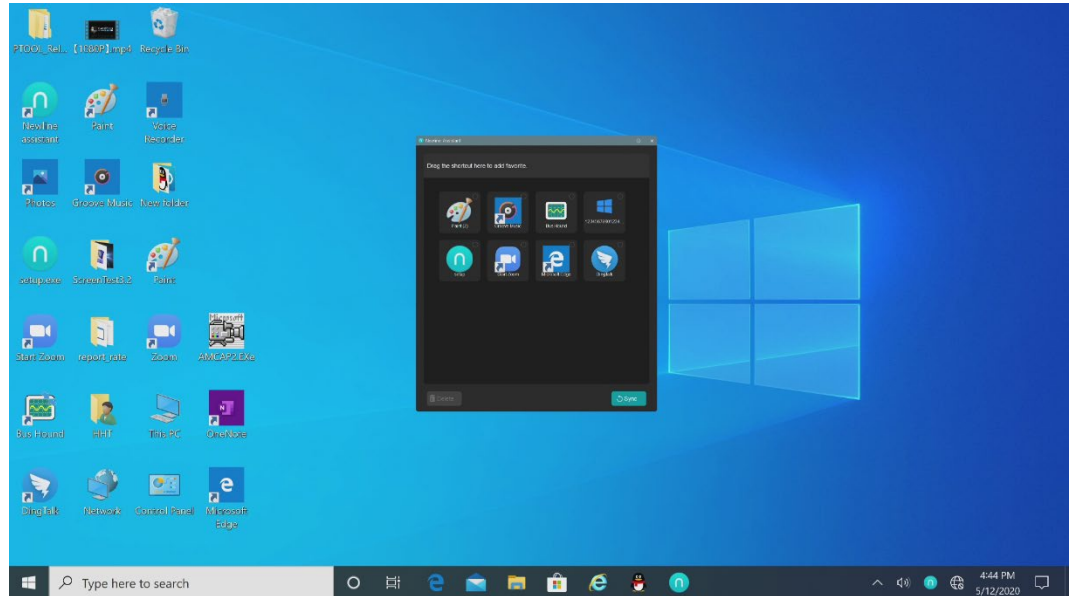

Step 2. Click the  icon in the sidebar to enter gadget interface to view all the Windows software shortcuts added by the Newline Assistant in Step 1.

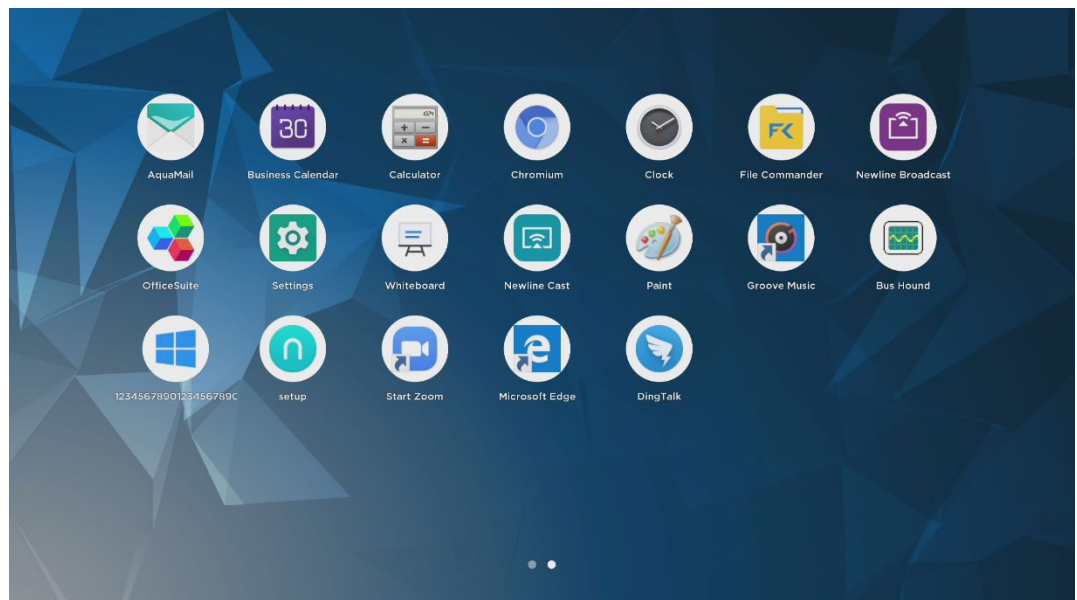

Step 3. In the gadget interface. Click the icon of an added Windows application to start the software.

# 6 Quick Setting Menu





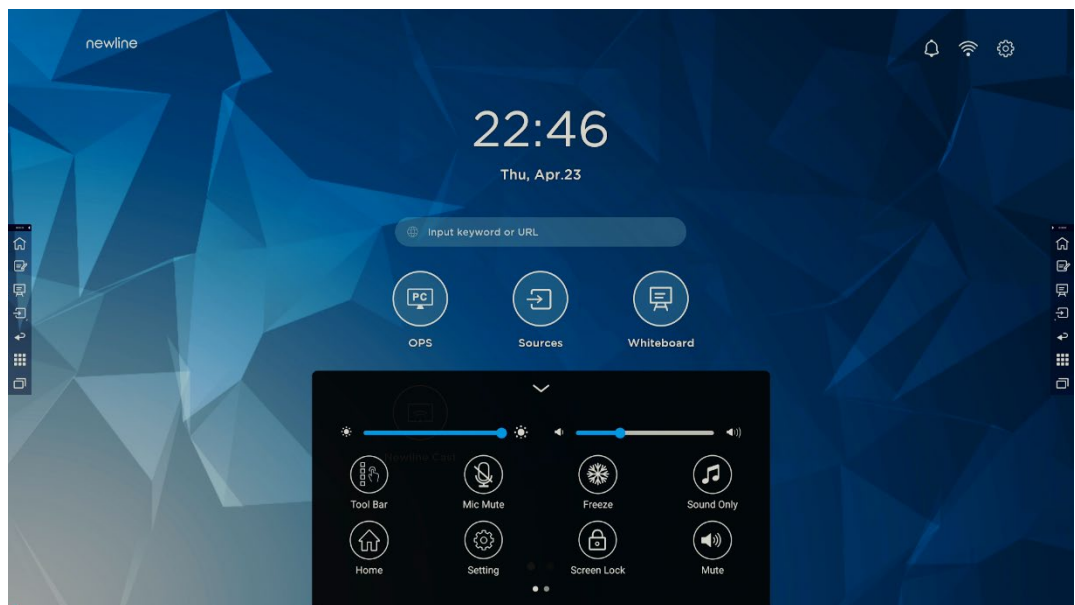

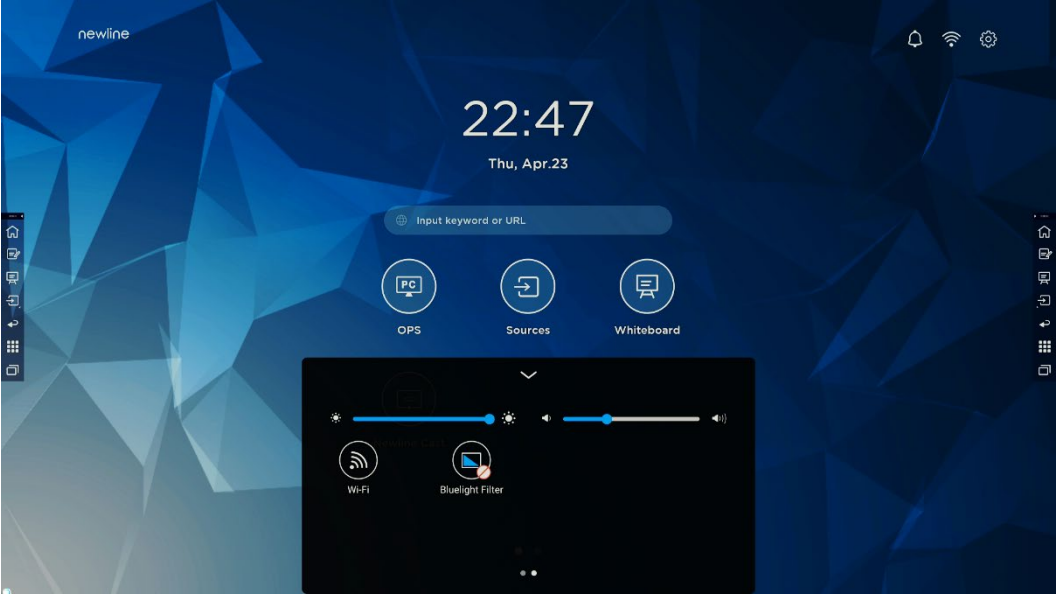

---





Using two fingers to swipe up from the bottom of the screen, the Quick Settings menu will appear, click wherever outside of the menu to hide the quick setting menu. As shown in the following figure.



In the quick settings menu interface, swipe left or right with your finger to switch the page, as shown in the following figure:



Icon	Name	Functions
	brightness	Drag the slider to adjust the brightness.
	volume	Drag the slider to adjust the volume.
	Toolbar	Click the icon to turn on/off the toolbar.
	Microphone mute	Click the icon to mute/unmute Microphone.
	Freeze	Click the icon to enter/exit freeze function.
	Sound only	Click the icon to enable sound only mode. In sound only mode, the screen LCD displays and LED backlight turns off, other functions are in normal operating condition.
	Home	Click the icon to return to Home page.
	Setting	Click the icon to enter the settings page.

Icon	Name	Functions
	Screen Lock	Click the icon to enter/exit screen lock function. User can set the temporary passkey for locking the screen.
	Mute	Click the icon to <b>mute or unmute</b> .
	Wi-Fi	Click the icon to turn on/off the Smart system Wi-Fi.
	Bluelight Fliter	Click the icon to turn on/off the blue light filter.

For more product information, please visit <https://newline-interactive.com>

National Service Hotline: +1 888 233 0868

The company is committed to product updates and technical improvements. The technical parameters and specifications are subject to change without prior notice. The pictures in this manual are for reference only.