

newline



Welcome to the world of Newline.

Thank you for choosing the Newline NT series Interactive Intelligent Display. Please use this document to get the most out of your screen.

This device complies with part 15 of the FCC Rules. Operation is subject to the following two conditions:(1) This device may not cause harmful interference, and (2) this device must accept any interference received, including interference that may cause undesired operation.

NOTE 1: This equipment has been tested and found to comply with the limits for a Class B digital device, pursuant to part 15 of the FCC Rules. These limits are designed to provide reasonable protection against harmful interference in a residential installation. This equipment generates, uses and can radiate radio frequency energy and, if not installed and used in accordance with the instructions, may cause harmful interference to radio communications. However, there is no guarantee that interference will not occur in a particular installation. If this equipment does cause harmful interference to radio or television reception, which can be determined by turning the equipment off and on, the user is encouraged to try to correct the interference by one or more of the following measures:

- Reorient or relocate the receiving antenna.
- Increase the separation between the equipment and receiver.
- Connect the equipment into an outlet on a circuit different from that to which the receiver is connected.
- Consult the dealer or an experienced radio/TV technician for help.



NOTE 2: Any changes or modifications to this unit not expressly approved by the party responsible for compliance could void the user's authority to operate the equipment.

The symbol of the crossed out wheeled bin indicates this product should not be placed in municipal waste. Instead, dispose of waste equipment by handing it over to a designated collection point for the recycling of electrical and electronic equipment.









Symbol Conventions

Symbols are used in this document to indicate operations that require special attention. The symbols are defined as follows:



 NOTE	Provides additional information to supplement operation in the main text.
 CAUTION	Indicates a potentially hazardous situation that, if not avoided, could result in equipment damage, data loss, performance deterioration, or unanticipated results.
 WARNING	Indicates a hazard with risk that, if not avoided, could result in death or injury.

Safety Instruction



For your safety, please read the following instruction before you use the product. Serious injury or property damage may be caused by improper operations. Do not try to repair the product on your own.

 WARNING	
	<p>Disconnect the product from power supply immediately if major failures occur.</p> <p>Major failures include the following:</p> <ul style="list-style-type: none"> • Smoke, peculiar smell or abnormal sound is discharged from the product. • No image or sound is displayed, or the image error occurs. <p>In the preceding scenarios, do not continue to use the product. Disconnect power supply immediately and contact professional staff for troubleshooting.</p>
	<p>Do not drop liquid, metal or anything combustible into the product.</p> <ul style="list-style-type: none"> • If any liquid or metal is dropped into the product, power off the product and disconnect power supply, then contact professional staff for solutions. • Pay attention to children when they are close to the product.
	<p>Put the product on a stable surface.</p> <p>An unstable surface includes and does not limited to an inclined plane, a shaky stand, desk or platform, which might cause turnover and damage.</p>
	<p>Do not open the cover or change the product on your own.</p> <p>High voltage components are installed in the product. When you open the cover, high voltage, electric shock, or other dangerous situations may occur.</p> <p>If inspection, adjustment, or maintenance is required, contact the local distributor for help.</p>
	<p>Use the specified power supply.</p> <ul style="list-style-type: none"> • To prevent the product from being damaged, do not use any types of power cables other than the one provided with the product. • Use a three-wire socket and ensure that it is properly grounded. • Pull out the power plug from the socket if the product is not used for a long period. <p>Clean the dust and metal on the power plug regularly.</p> <ul style="list-style-type: none"> • Fire or electric shock may be caused if the product is powered on, when you are cleaning. • Pull out the power plug before cleaning it with a dried cloth.
	<p>Do not put items on the top of the product.</p> <ul style="list-style-type: none"> • Do not put items, such as a container for liquid (a vase, flowerpot, cosmetics or liquid medicine) on the top of the product. • If any water or liquid is spilled on the product, a short circuit may occur and cause fire or electric shock. • Do not walk on or hang any items on the product.

WARNING

	<p>Do not install the product in an improper place.</p> <ul style="list-style-type: none">• Do not install the product in humid places, such as the bathroom, the shower room, near windows, or outdoor environments that experience rain, snow or other harsh weather. Avoid installation near hot spring vapor. The preceding environments may cause faults in the product or electric shock under extreme conditions.• Do not put exposed fire source, such as an ignited candle, on the product.
	<p>Pull out the power plug during thunderstorms.</p> <ul style="list-style-type: none">• Do not touch the product during a lighting storm to avoid electric shock.• Install or place components that supply high enough voltage to cause personal injury out of the reach of children.
	<p>Do not touch the power cable with wet hands.</p>

CAUTION

	<p>Do not install the product in high temperature environments.</p> <ul style="list-style-type: none">• Do not install the product near a heat source, such as a radiator, a heat reservoir, a stove or other heating products.• Do not expose the product to direct sunlight, which may cause high temperatures and subsequent faults in the product.
	<p>For transport:</p> <ul style="list-style-type: none">• Pack the product for transport or maintenance by using the cartons and cushioning material provided with the product.• Vertically move the product during transport. The screen or other components are easily broken if the product is moved by an improper way.• Before you move the product, disconnect all external connections and separate all toppling preventing products. Move the product carefully to prevent it from being hit or squeezed, especially the screen, which may cause injury if broken.
	<p>Do not cover or block up any vents on the product.</p> <ul style="list-style-type: none">• Any overheated components may cause fire, damage the product, and shorten the service life.• Do not lay the product down where the venting surface will be covered.• Do not install the product on a carpet or cloth.• Do not use a cloth such as table cloth to cover the product.

CAUTION

Keep away from the product when you use a radio.
The product complies with the international EMI standard to prevent radio interference. However, interference may still exist and cause noise in the radio. If noise occurs in the radio, try the following solutions.

- Adjust the direction of the radio antenna to avoid the interference from the product.
- Keep the radio away from the product.

Screen glass is broken or falls off.

- In case of screen glass breakage, keep all personnel 3 meters away from the screen to ensure safety.
- Do not perform any installation or disassembly when the screen glass is broken or falls off.

Use the battery correctly.

- Galvanic corrosion, electric leakage, and even fire may be caused by improper battery usage.
- It is recommended to use the designated type of battery and install the battery by correct electrodes (positive and negative).
- Do not install and use new battery with a used one.
- Take out the battery if the remote control is not used for a long period.
- Do not expose the battery to overheated environments such as sunlight and firing.
- Dispose of the used battery based on your local regulations.

Do not damage the power cable.

- Do not damage, change, twist, bend, or forcibly drag the power cable.
- Do not put weights (such as the product itself) on the power cable.
- Do not forcibly drag the cable when you pull out the power plug. If the power cable is damaged, please contact the local distributor to repair or replace it.
- The power cable in the accessory box is for this product only. Do not use it on other products.

Additional advice:

- Use the product in an environment with comfortable lighting. It is harmful to your eyes to watch in a too bright or too dark environment.
- Relax your eyes after a period of time for watching.
- Keep sufficient distance from the product to protect your eyes and prevent eyestrain.
- Adjust the volume to an appropriate level, especially at night.
- Use amplifier equipment as the audio input source with caution. If you must use amplifier equipment, the input power should not exceed the maximum of speaker power. Otherwise, the speaker can become overpowered and damaged.

About USB port.
Rear USB 3.0 ports switch connections based on signal sources. If the current signal source is reading the data from an external product connecting to the port, please switch the signal source after the data reading is complete. Otherwise, the data or product may be damaged.



A

Parts and Functions

Parts

◆ Front View

- TT-8519NT:

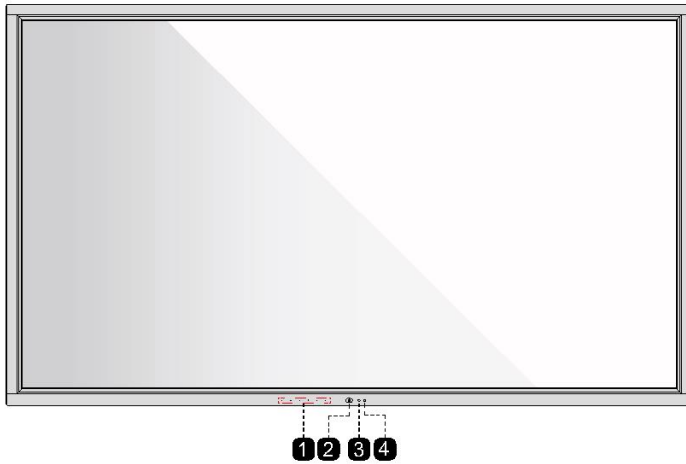

- TT-9819NT:

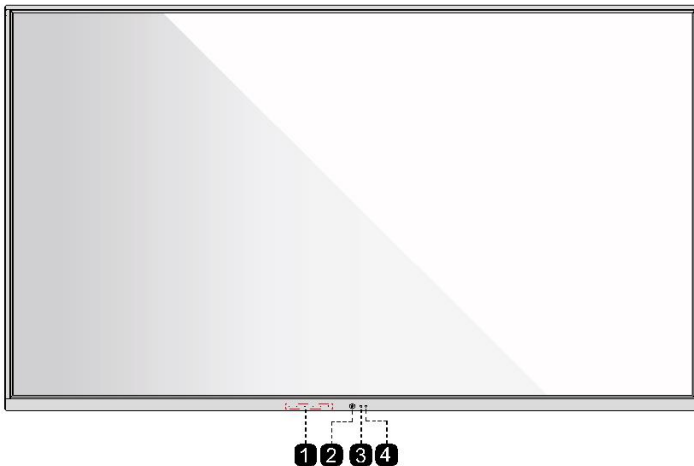

◆ Rear View

- TT-8519NT:

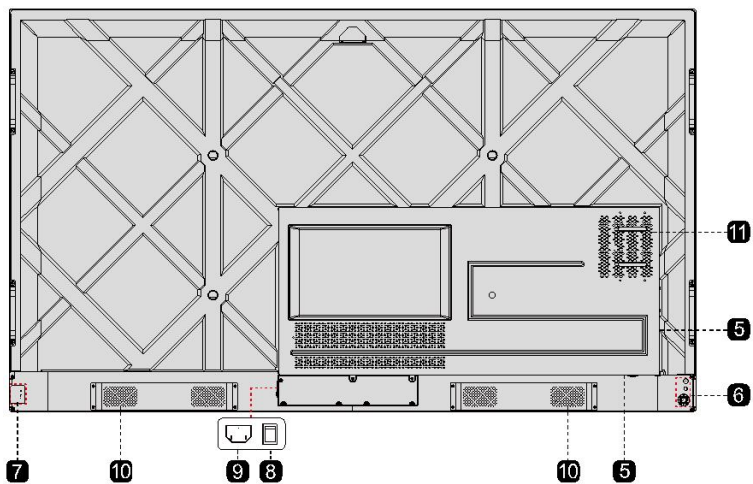

- TT-9819NT:

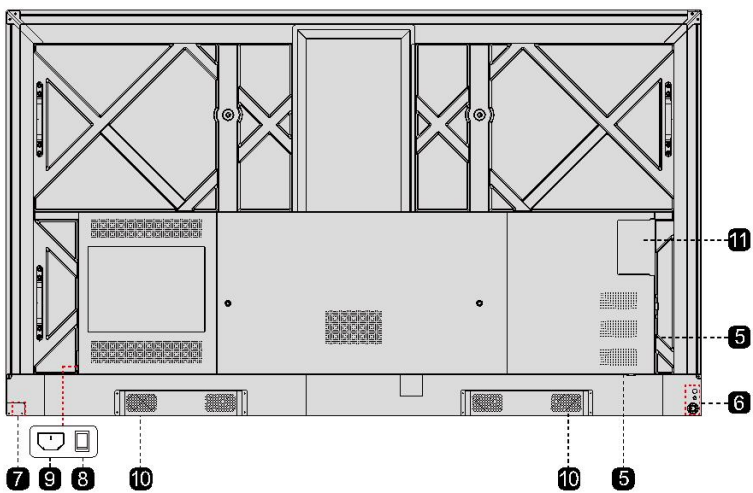

- | | |
|---------------------------|---------------------|
| 1 MIC | 7 USB3.0 |
| 2 Power On/Off | 8 Power Switch |
| 3 Remote Control Receiver | 9 Power Supply Plug |
| 4 Optical Inductor | 10 Speakers |
| 5 Rear Ports | 11 Internal PC Port |
| 6 Rear Buttons | |

Ports

◆ Front Buttons

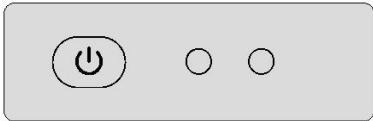

Button	Operations	Function description
	Short press	Power on/Sleep mode
	Long press(3 seconds)	Power off

◆ Rear Ports



CAUTION

Rear USB 3.0 ports switch connections based on signal sources. If the current signal source is reading the data from an external product connecting to the port, please switch the signal source after the data reading is complete. Otherwise, the data or product may be damaged.

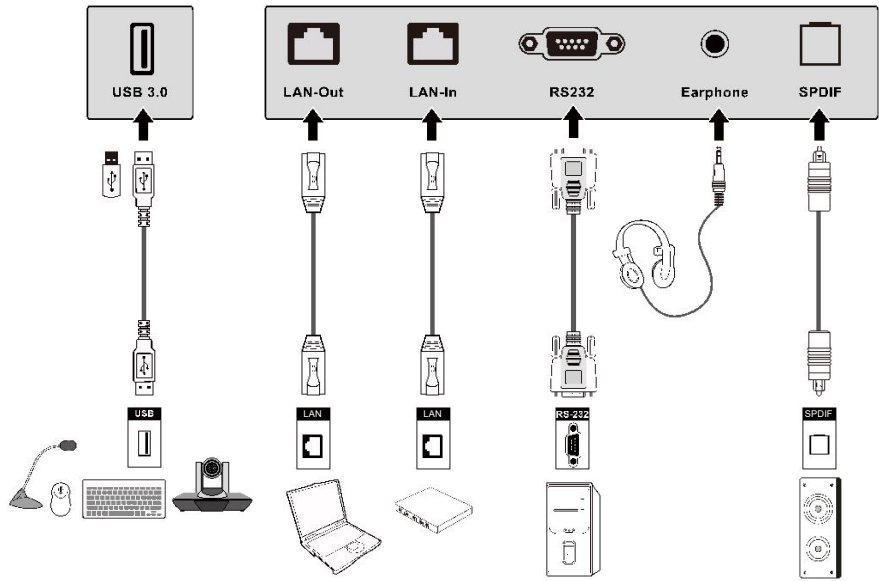
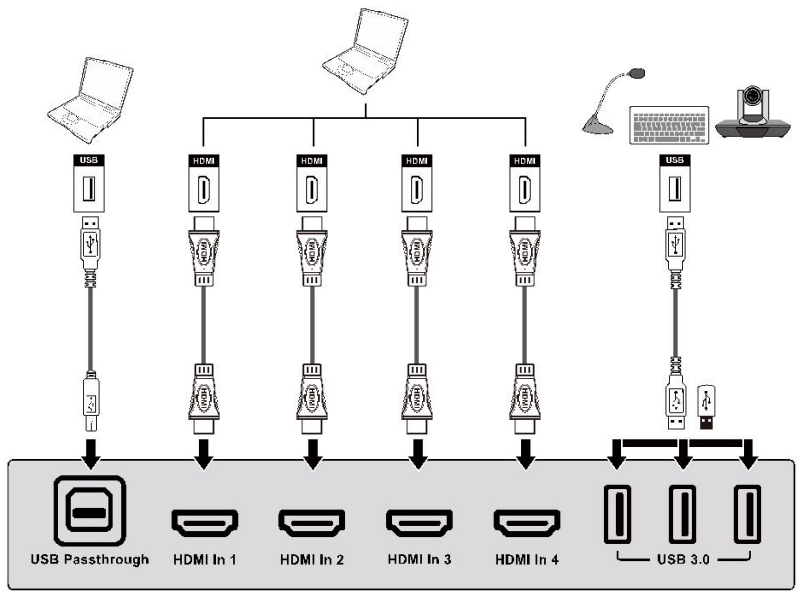



Note

- When using the 2.4G wireless mouse, we recommend using the USB port on the lower right side of the back panel.
- Please do not connect a 2.4G wireless mouse and USB 3.0 devices simultaneously, on the left side of the back panel, in order to avoid the interference.

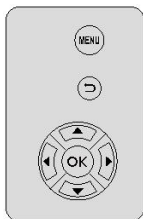
◆ Rear Buttons



Button	Operations	Function description
MENU	Short press	Open/Exit the system menu
	Short press	Return to Previous/Exit
OK	Short press	Confirm/OK
	Short press	Up/Down/Left/Right

Remote Control



CAUTION

Carefully read the following instructions before using the remote control to avoid possible faults:

- Do not drop or damage the remote control.
 - Do not spill water or other liquids on the remote control.
 - Do not place the remote control on a wet object.
 - Do not place the remote control under direct sunlight or near an overheating heat source.
-

Remote Control

◆ Remote Control Buttons



Keyboard

Buttons	Function
	Power on/off.
	Mute/Unmute Audio
HOME	Enter Home/Home source
	Open the system menu
	Return to Previous/Exit
	Up/Down/Left/Right
	Confirm/OK
	Mouse left Button : pointing, clicking, etc. Please enable the mouse then use it.
MOUSE MODE	Open/turn off the wireless mouse mode
	Switch back light mode

Buttons	Function
	Mouse Right Button: click to exit Android app. Please enable the mouse mode then use it.
	Mute/Unmute Microphone
	Short Press: Increase the sound volume Long Press: Increase the sound volume continuously
	Short Press: Decrease the sound volume Long Press: Decrease the sound volume continuously
	Freeze the Current Screen, Click Again to Exit Freeze Function
	Enable Sound Only Mode, Click Again to Exit the mode
keyboard	An input device of the display, it can input English letters, Numbers, punctuation, etc.

B

Installation Guide

Safety Precautions

◆ Installation Environment



◆ Installation Direction

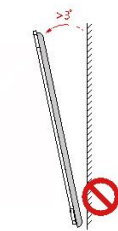
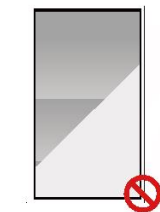
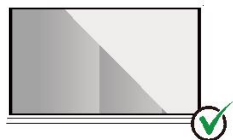

Installation Precautions

◆ Weight Loading

Weight of the product:

TT-8519NT net weight: 46.5 kg(± 2 kg).

TT-9819NT net weight: 84.0 kg(± 2 kg).

- When using a mobile stand, ensure that the weight of the product is less than the loading capacity of the mobile stand.
- When using the wall-mount bracket, ensure that the wall can support the weight of the product. We recommend that the wall surface be reinforced and have a loading capacity 4 times of the weight of the product. Consult a professional installer for wall-mount installation.

📄 Note

- The company does not undertake relevant legal responsibility for any problems caused by improper operation, if the third party mobile stand, or wall-mount bracket is beyond the scope of the product.
- Do not install the product where it might be hit by a door.

◆ Vertical installation

When installing, try to keep the product vertical. The vertical tilt range allowing for wall-mount installation is ± 3 degrees. Excessive tilt angle may cause the screen glass to fall off or the product to collapse.

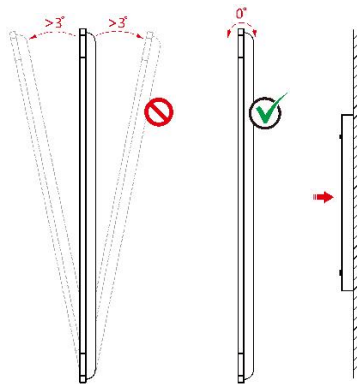

📄 Note

For any problem, please contact our support desk. Our company is not responsible for any damage or losses incurred by users if the users fails to follow the instructions.

Ventilation

Ensure adequate ventilation and/or air conditioning environment. We recommend keeping certain distances from the side of the product to the wall or panels. Ventilation requirements are shown in following figure.

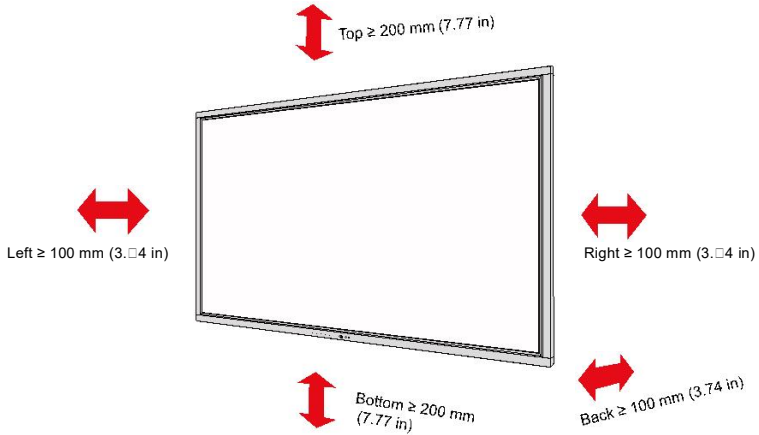

Installation

The dimensions of the four bracket mounting holes on the back panel are VESA MIS-F compliant (TT-8519NT: 800 x 400 mm/31.50 x 15.75 in; TT-9819NT: 800 x 600 mm/31.50 x 23.62 in). Use metric M8 screws with length of 10 mm to 15 mm (0.40 to 0.59 in) to secure the screen with the mounting system. Dimensions of the mounting holes on the back panel are shown on the following figure.

Note

Consult a professional installer to install the display product.

85"

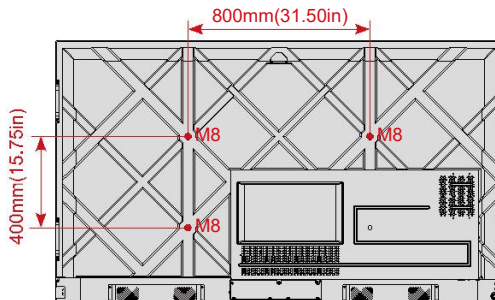

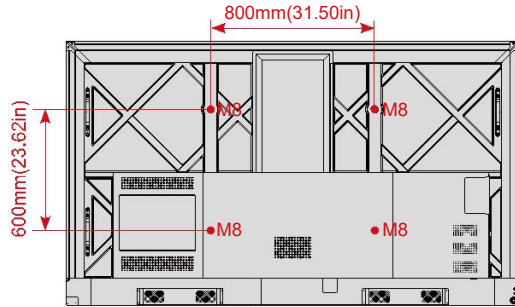

Installing the Internal PC (Optional)



CAUTION

The internal PC does not support hot plugging. Therefore, you must insert or remove it when the screen is powered off. Otherwise, the screen or internal PC may be damaged.

You will need to purchase the internal PC separately. Perform the following steps to install the internal PC.

Step 1: Unscrew the M3 screws by hand to remove the internal PC shielding cover.

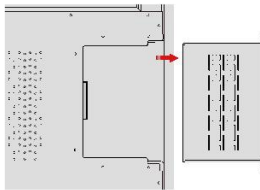

Step 2: Push the internal into the internal PC port at the rear of the screen from right to left.

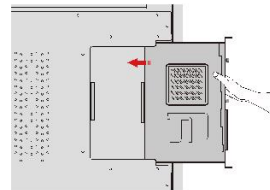

Step 3: Secure the internal PC to the display by using the M3 screws.

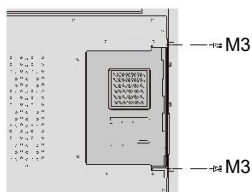

Step 4: Ensure the installation is correct before turning the power on again.

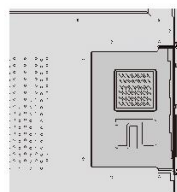

C

Turning On/Off

Power On



Step 1: Plug the power supply into the power outlet fully and plug the power connector into the side of the product. Ensure the power is in the range of 100 V to 240 V with frequency at 50 Hz/60 Hz \pm 5%. The power current must be grounded.

Note

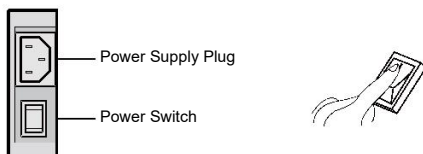

The power outlet should be installed near the equipment and shall be easily accessible.

Step 2: Flip on the power switch located on the side of the product to “On”.



Step 3: Press the power button “” on the front control panel or “” on the remote control.

Power Off

Step 1: Long press the power button “” on the front panel or press the power button “” on the remote control, the power indicator will turn to red.

Step 2: If you are not going to use the product for an extended period of time, we recommend you to switch the power switch to “Off”.

Note

- If an internal PC is equipped, the internal PC and the screen are powered off simultaneously when you power off the system.
- Do not forcibly disconnect the power supply of the screen when the internal PC is on.

D

Operating the Intelligent Display

Boot-up Screen

When the product is turned on, the product will show the boot-up page. As shown in the following figure.



Initial Setting

When starting up for the first time, the system automatically enters the initial setup interface , as the following steps:

Step 1: Language Choice:

Press the Up and Down button on the remote control or on the rear control panel to select the language you want, then press the button “ ” on the remote control, or press the button “ ” on the rear control panel to make a confirm, when the “OK” icon in the interface highlight, press the confirm button again to enter next step.

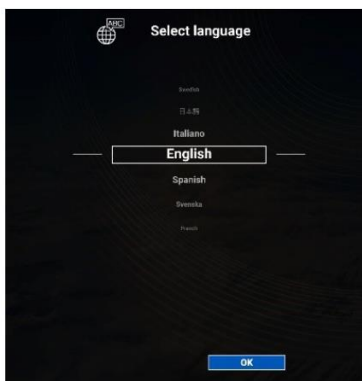

Step 2: Welcome Page

The welcome page show as in the following figure. Choose OK to enter the next step; Choose Skip to enter the Home Page straightly.



Step 3: Network Settings

Press the Up and Down button on the remote control or on the rear control panel to select the network you want, then choose OK to make a confirm; or choose Skip to enter the next step straightly.

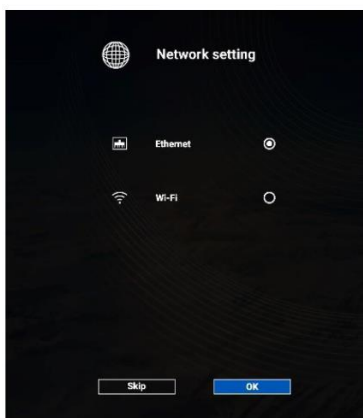

Note

Ethernet is defaulted by the system.

Step 4: System Update

If automatic update is detected by the system, the prompt page appears as following figure; Choose More Information to view more updates details; Choose OK to start update; Choose Skip to enter the next step straightly.

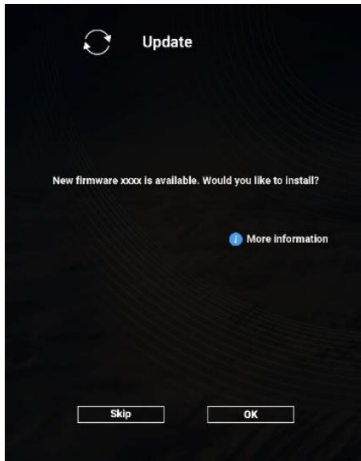

Step 5: Import

You can use USB flash memory to import the setting data to the product. Choose OK to start the import; Choose Skip to enter the next step straightly.

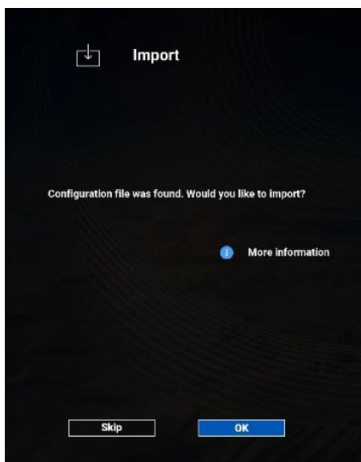

Note

If no USB flash memory, or no import file in it, system will enter to the next step straightly.

Step 6: Complete The Setting

Choose OK to enter the Home Page.

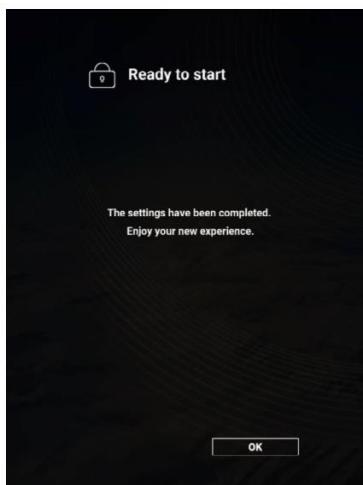

Welcome page

After setting, the system enter the welcome page, as shown in the following figure:

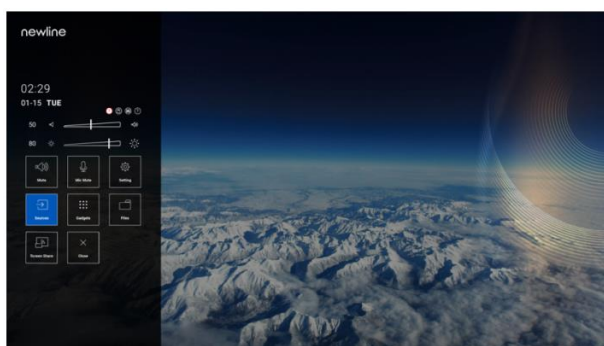



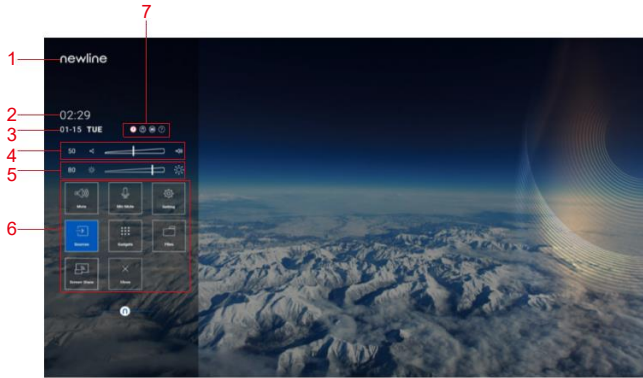





Enter the welcome page, you will see the menu page. If you don't want the menu page, you can press the menu button “☰” on the remote control or the button “⬛” on the rear control panel, then the product will exit the Menu page.



NO.	Name	NO.	Name
1	Logo	5	Adjust the Brightness
2	Clock (Shortcut to Clock)	6	Main Icon
3	Date and Week	7	Status Bar
4	Adjust the Sound Volume		

◆ Main Icon

Icon	Functions
	Mute/Unmute Audio.
	Mic Mute/Unmute.
	Click Connection to view the connected sources, including Internal PC, HDMI 1, HDMI 2, HDMI3, HDMI4.
	Gadget displays all pre-installed applications.
	Open the File Manager, and you can explore on internal and external files of the screen.
	Click the icon to enable the wireless screen sharing function.
	Click the icon to access the system setting page.
	Click the icon to close the menu.



More Information

For More Information

Please visit our website (www.newline-interactive.com) for detailed instruction manual.

Contact Us for Support

Please email us at support@newline-interactive.com.

Our company is devoted to product innovation and technology enhancement. Therefore, we may change product specs and information without notice, Product pictures in the manual are for reference only, please refer to actual products.